



Compressed Air Energy Management System

Company / customer

Project description

CS-4_V1

Job number

CAEMS_02

Commission

CAEMS

Manufacturer (company)

CAEMS

Path

Project name

CS-4_V1

Make

Type

Place of installation

Responsible for project

Part feature

Created on

18.1.2016

Edit date

26.10.2018

by (short name) Jernej V.

Number of pages

11

			Date	27.10.2017	Commission:	CAEMS	TITLE PAGE		= +	Page: 1 All pages: 11
			Ed.	Jernej V.	Project description:	CS-4_V1				
Modification	Date	Name	Original		Replacement of	Replaced by				

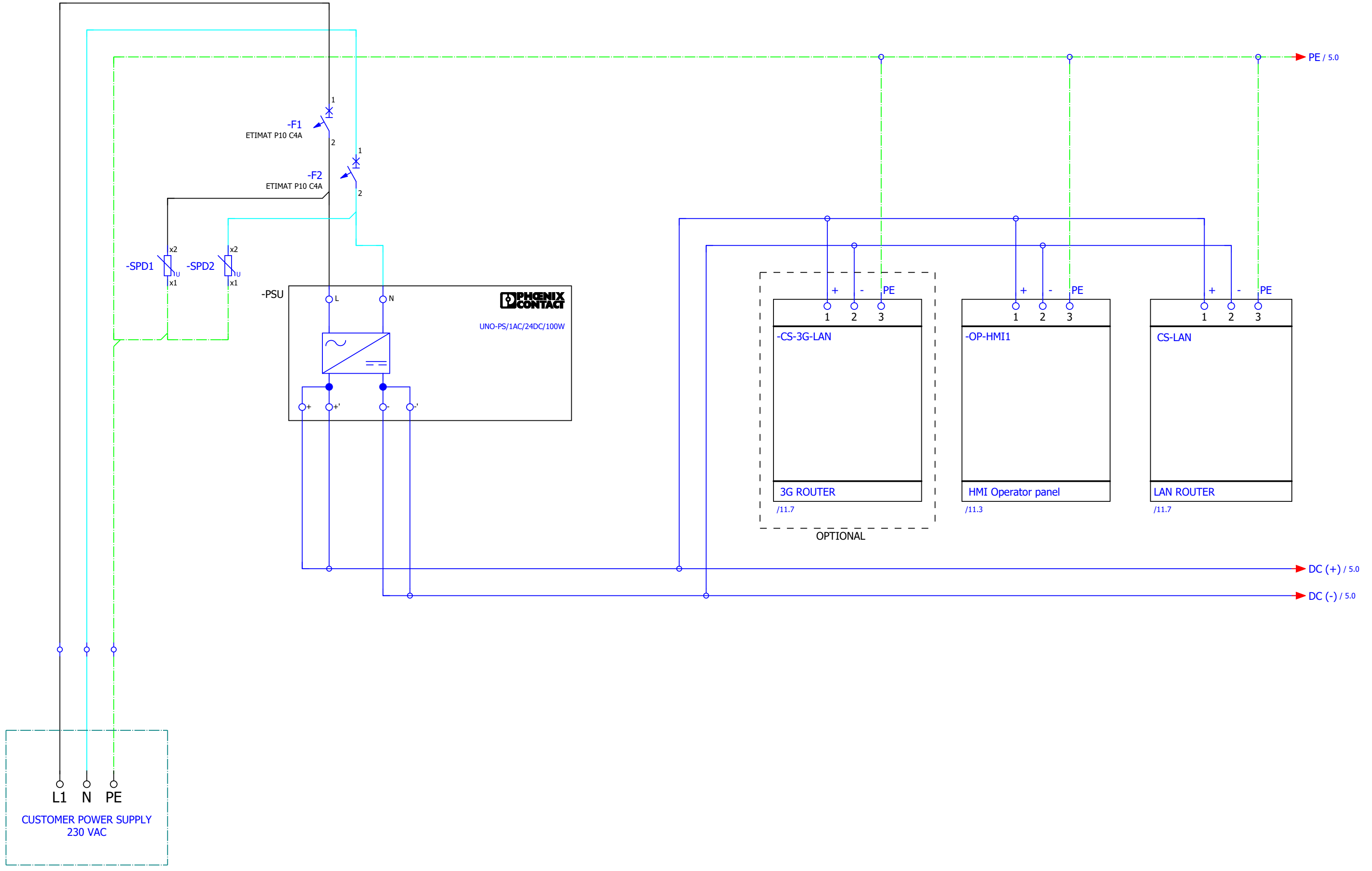

		Date	26.10.2018	Commission:	CAEMS	POWER SUPPLY				
		Ed.	Jernej V.	Project description: CS-4_V1				CAEMS_02	Page:	3
Modification	Date	Name	Original	Replacement of	Replaced by				All pages:	11

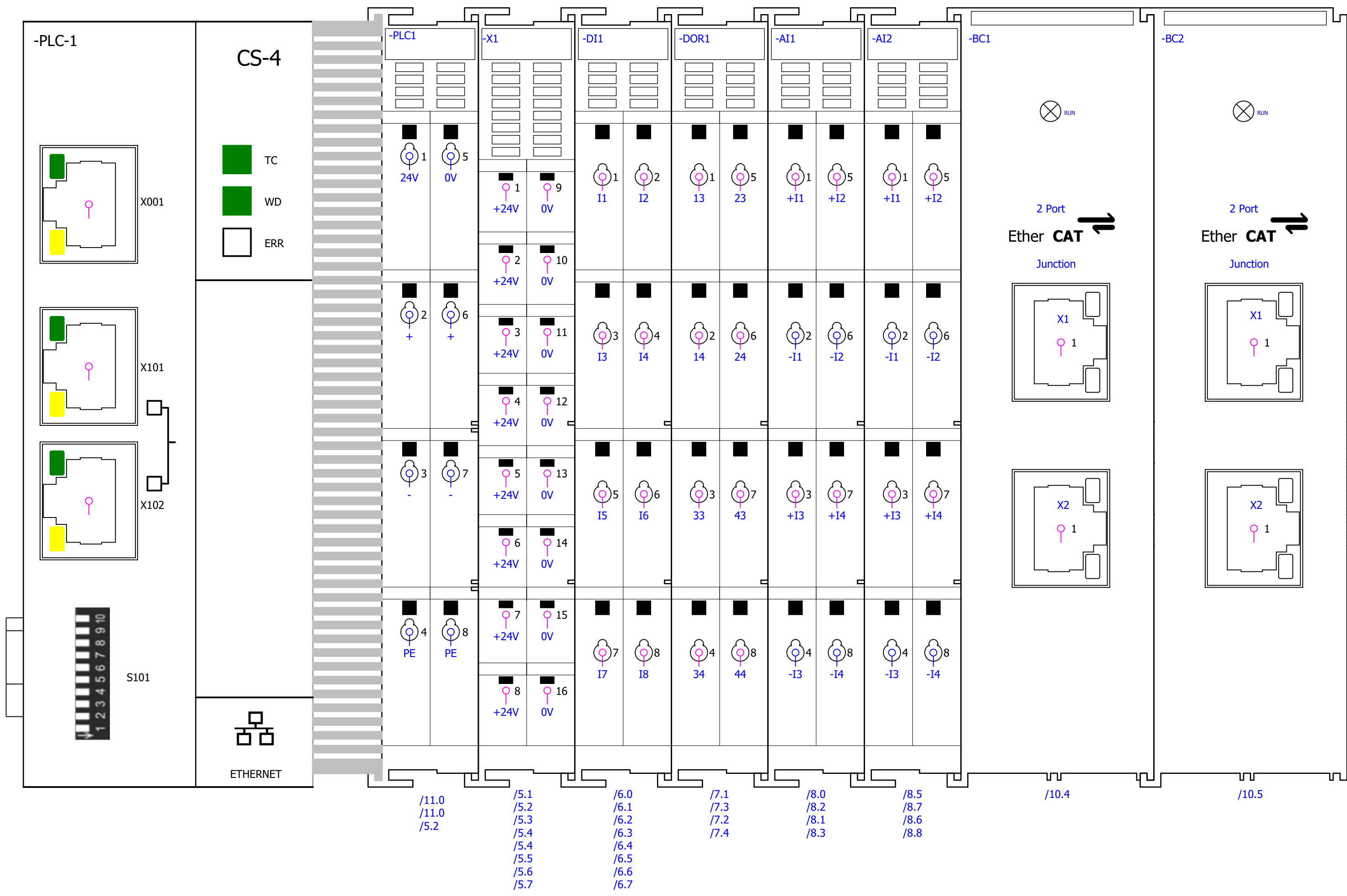

				Date	27.10.2017	Commission: CAEMS		PLC OVERVIEW			
				Ed.	Jernej V.	Project description: CS-4_V1					
				Appr		Replacement of		Replaced by			
Modification	Date	Name	Original							CAEMS_02	Page: 4
											All pages: 11



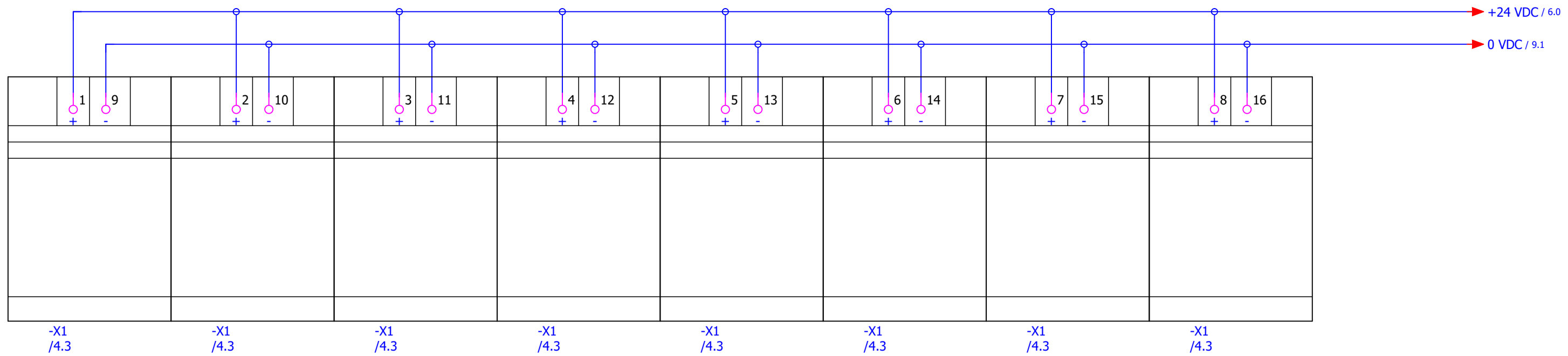
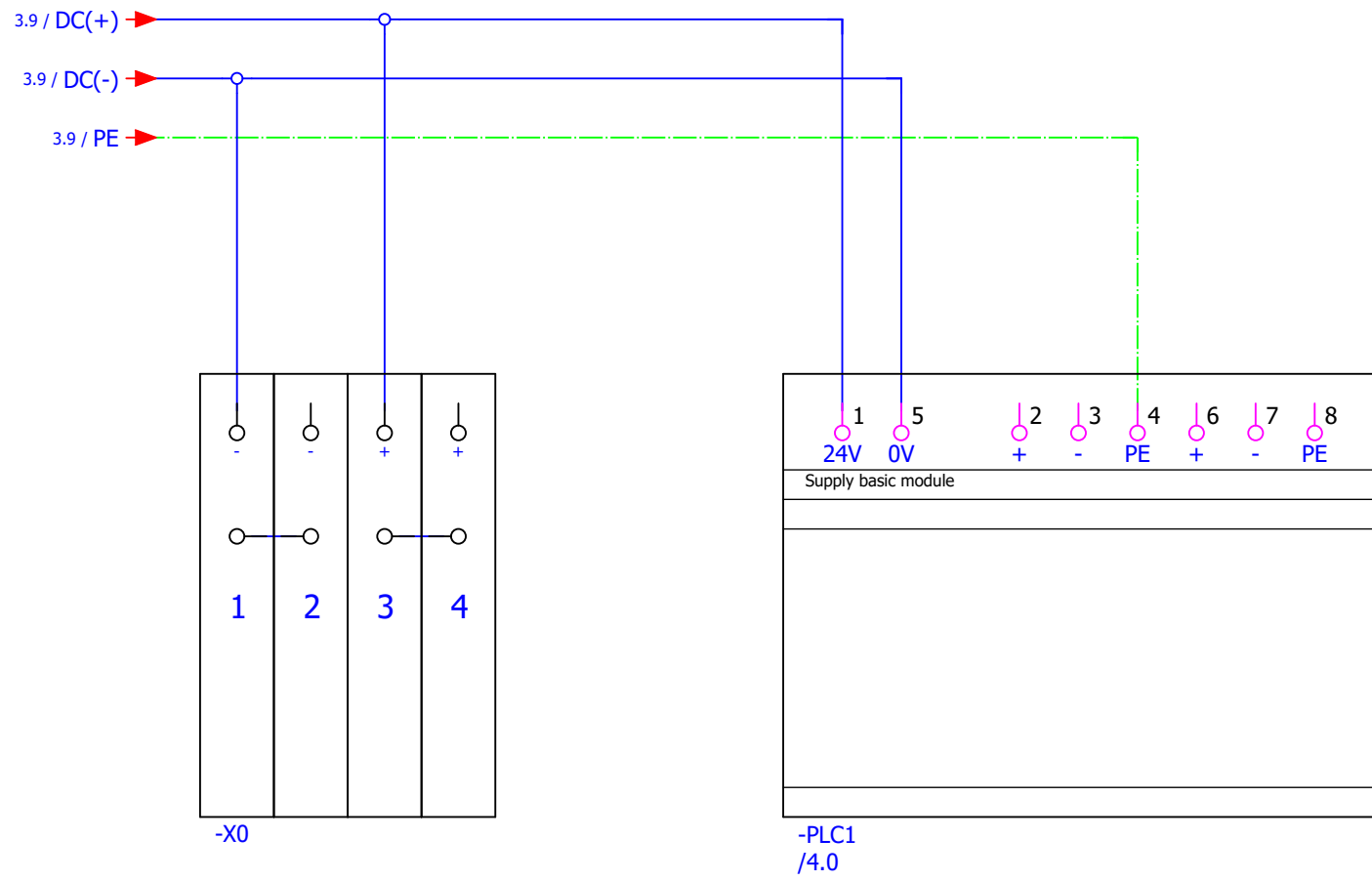

5.9 / +24 VDC → +24 VDC / 9.1

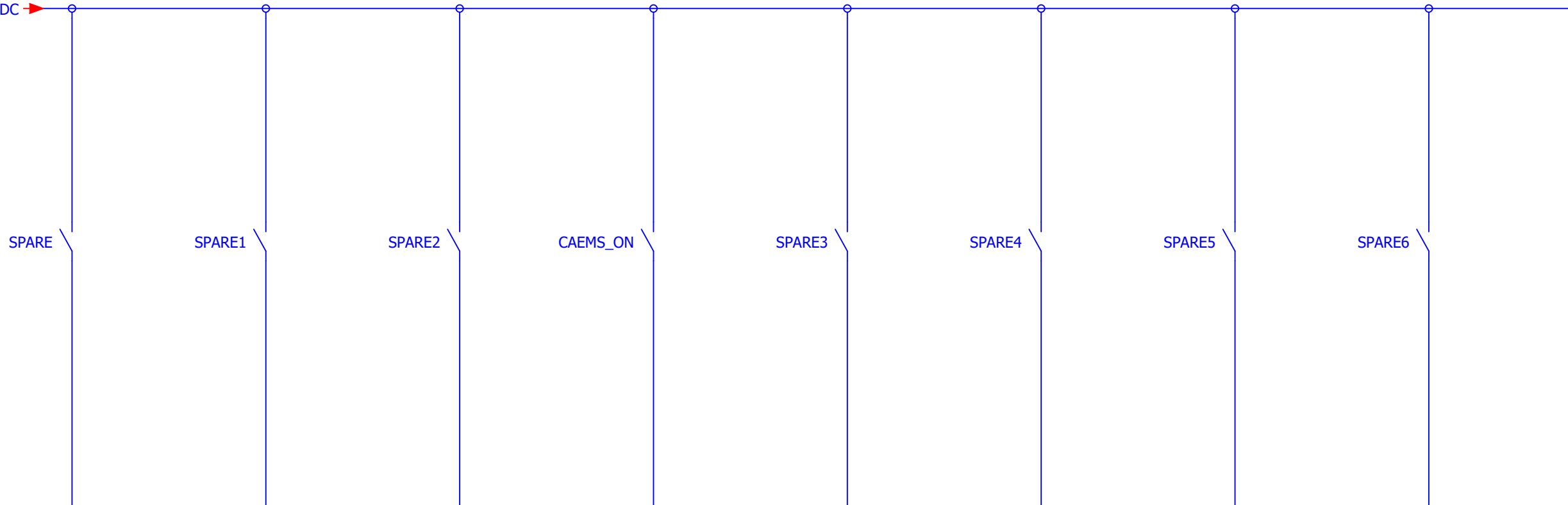

1 I1	2 I2	3 I3	4 I4	5 I5	6 I6	7 I7	8 I8
=+-SPARE	=+-SPARE1	=+-SPARE2	=+-CAEMS_ON	=+-SPARE3	=+-SPARE4	=+-SPARE5	=+-SPARE6
SPARE	SPARE1	SPARE2	CAEMS_ON	SPARE3	SPARE4	SPARE5	SPARE6
-DI1 /4.4	-DI1 /4.4	-DI1 /4.4	-DI1 /4.4	-DI1 /4.4	-DI1 /4.4	-DI1 /4.4	-DI1 /4.4

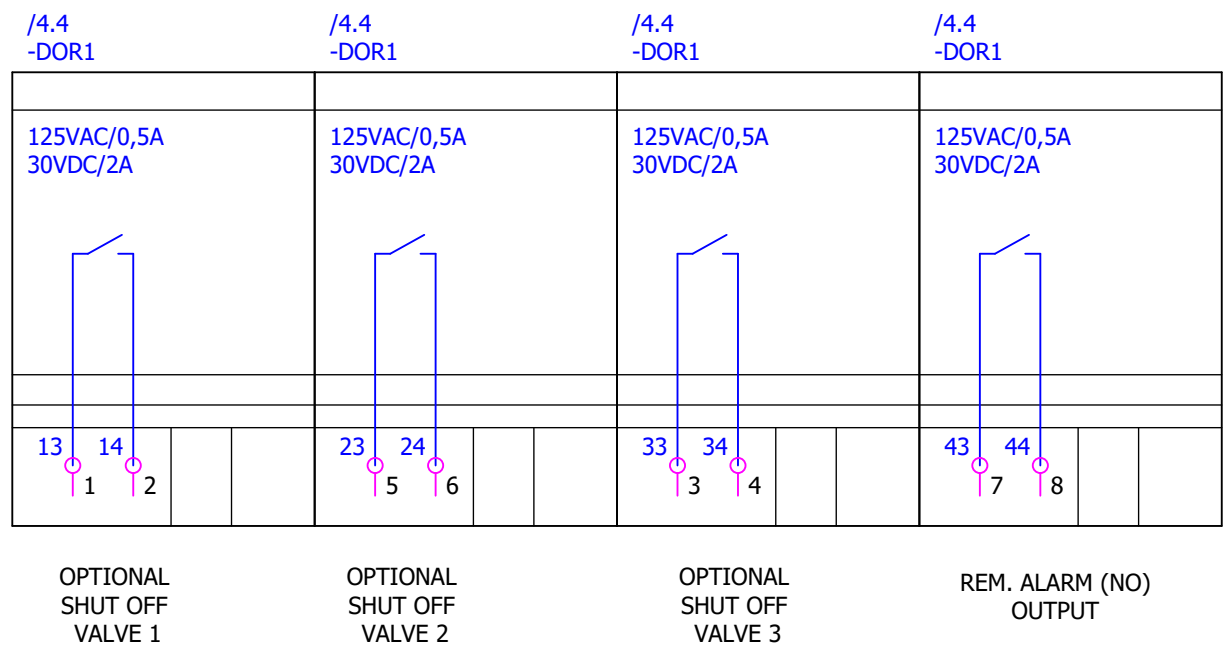

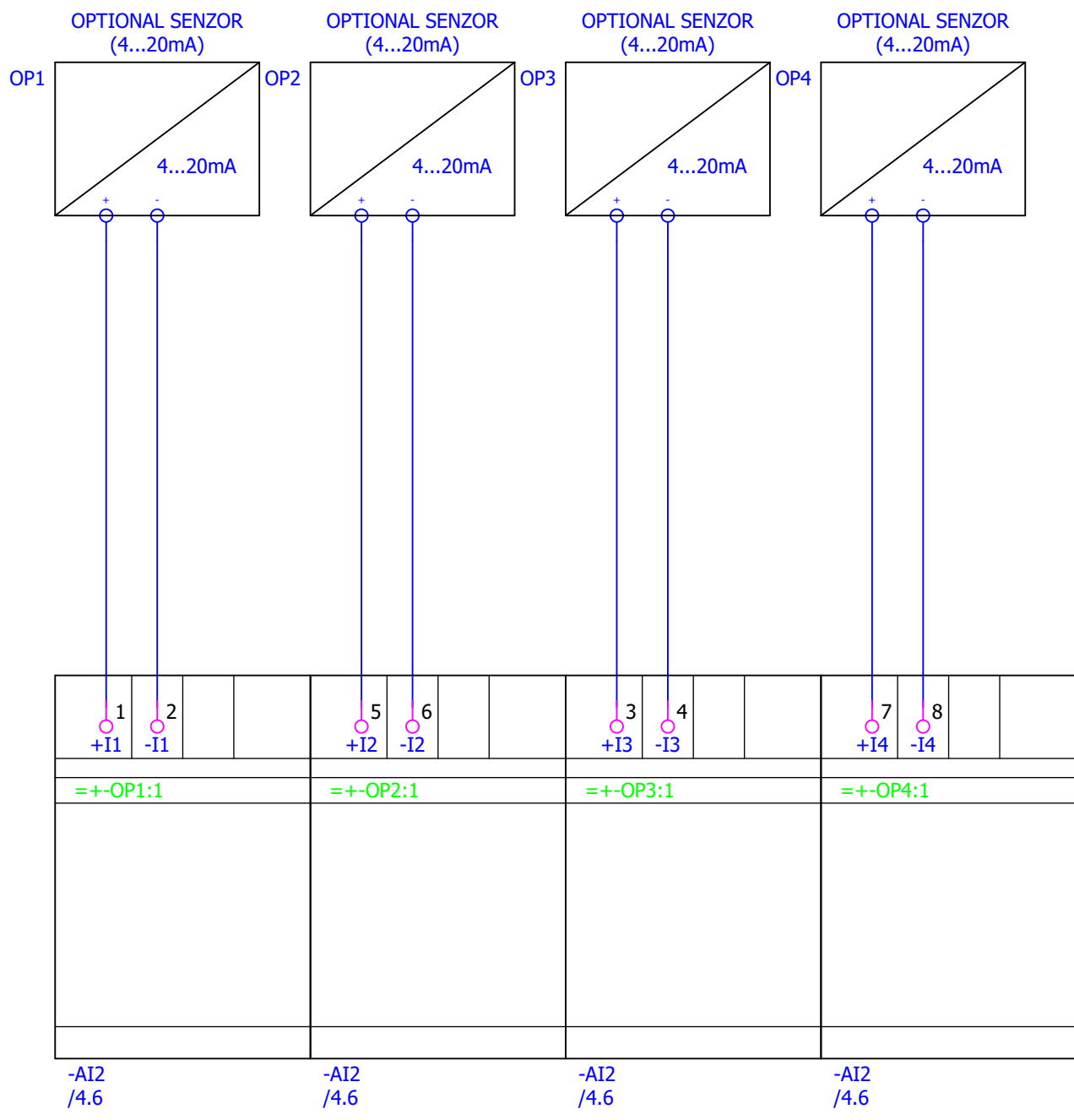
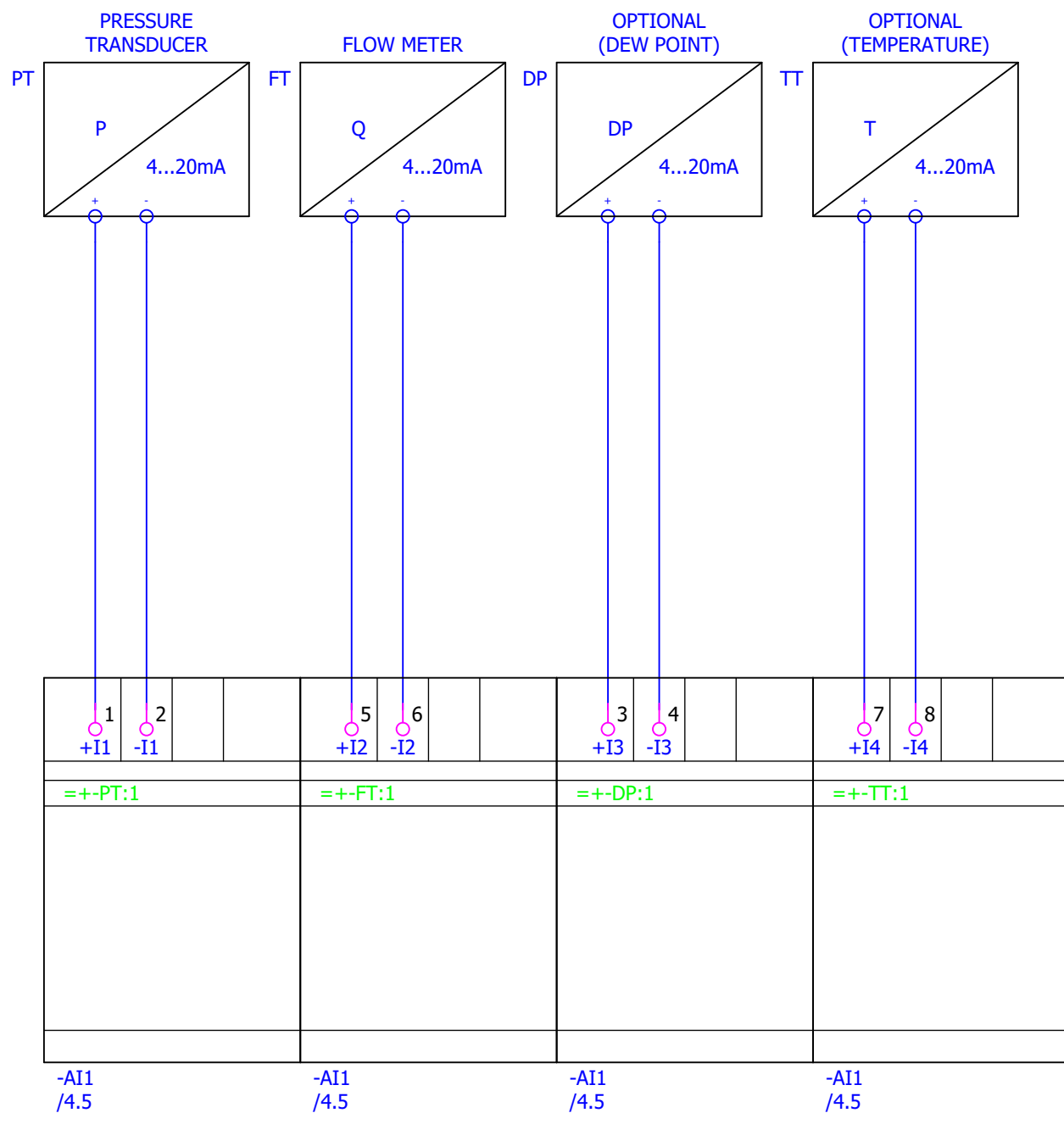

2-WIRE SENSOR - PASIVE_SENSOR

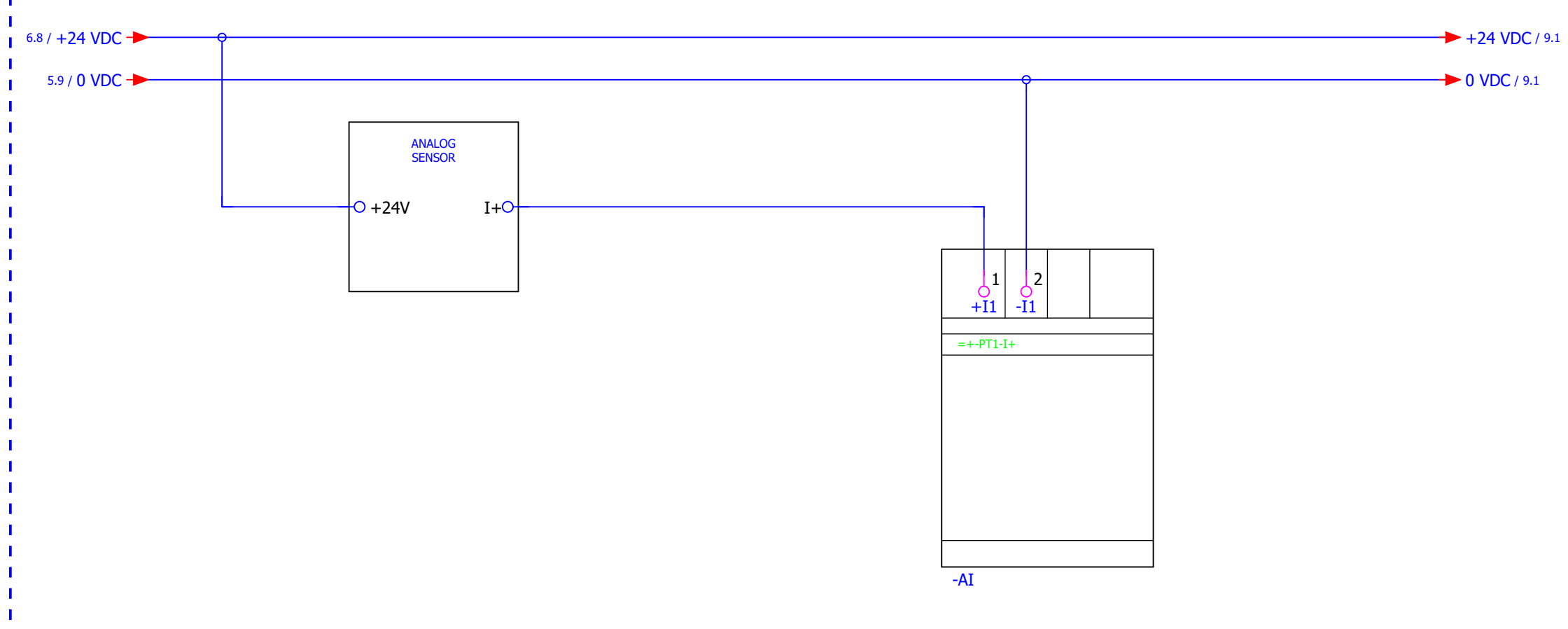

4-WIRE SENSOR - ACTIVE_SENSOR

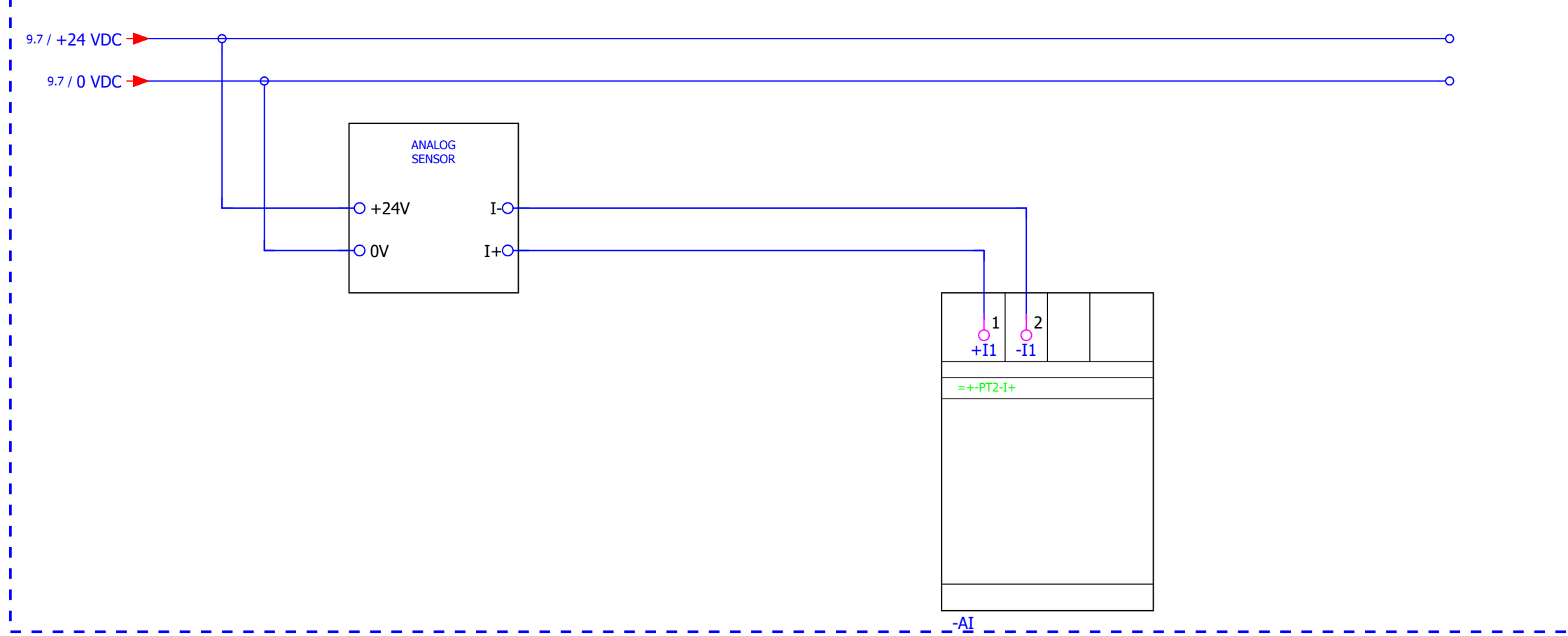

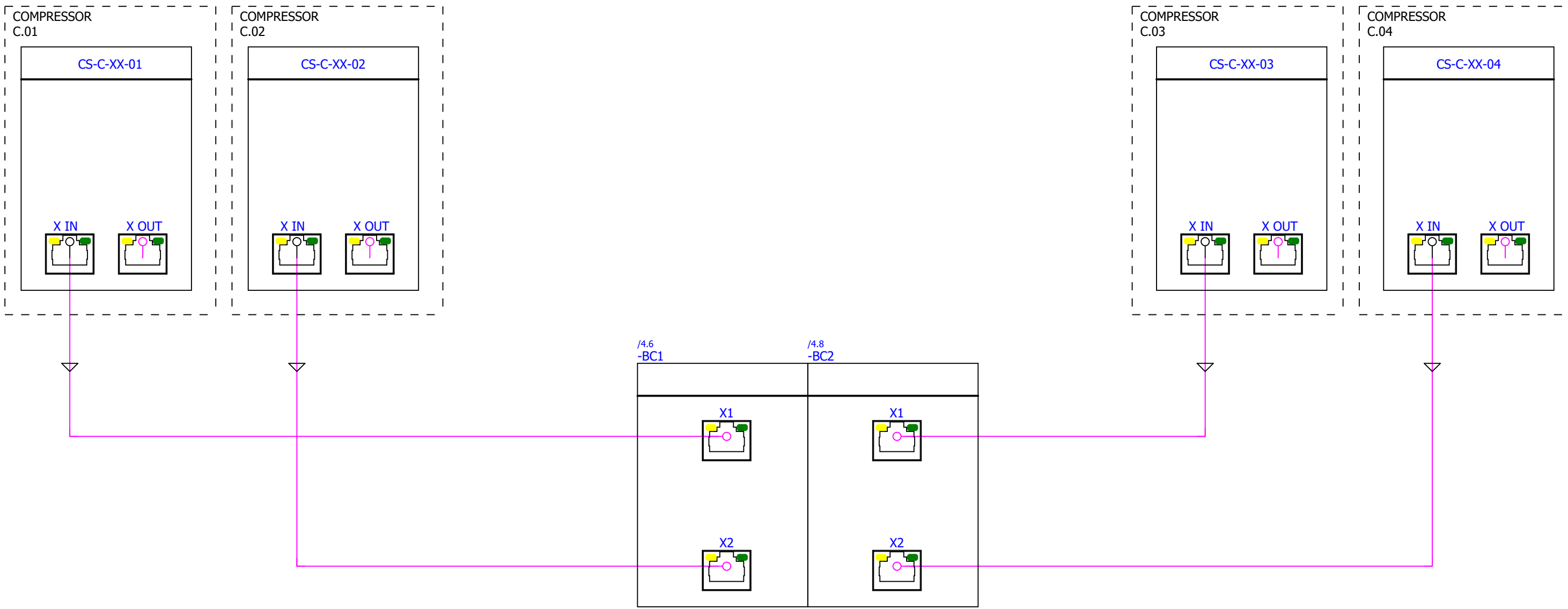

/4.0
-PLC1

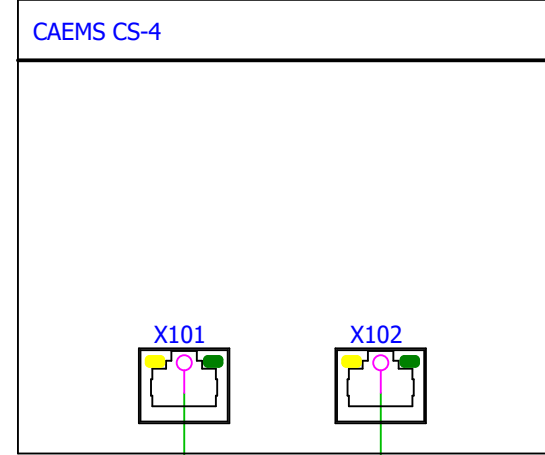

/11.3
/3.6
-OP-HMI1

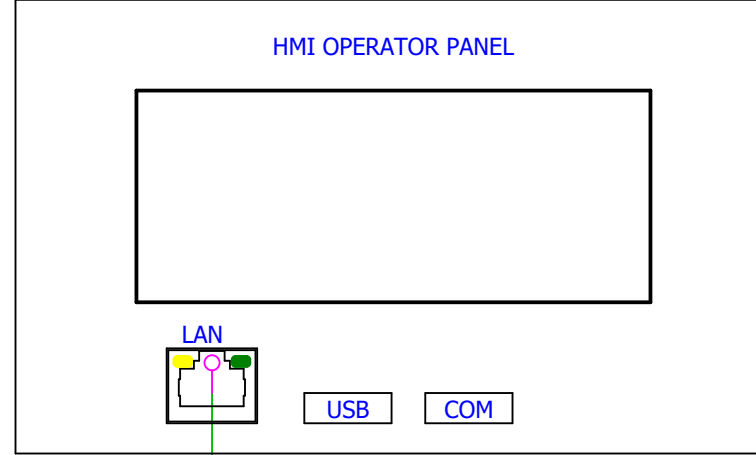

/3.8
-CS-LAN

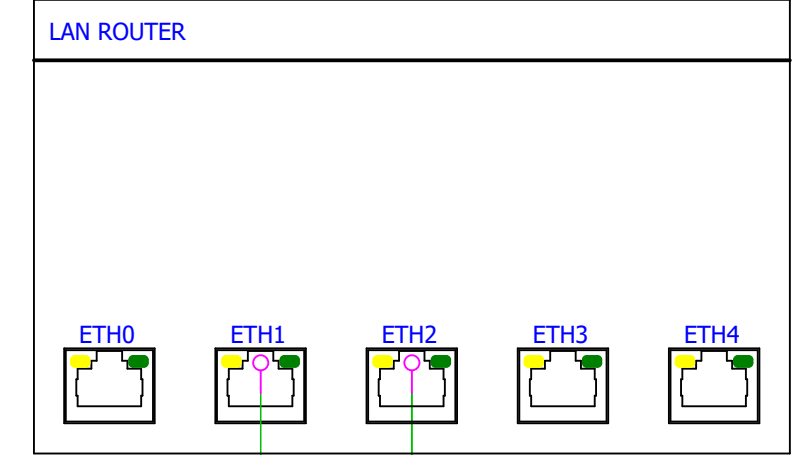

OPTIONAL

/4.0
-PLC1

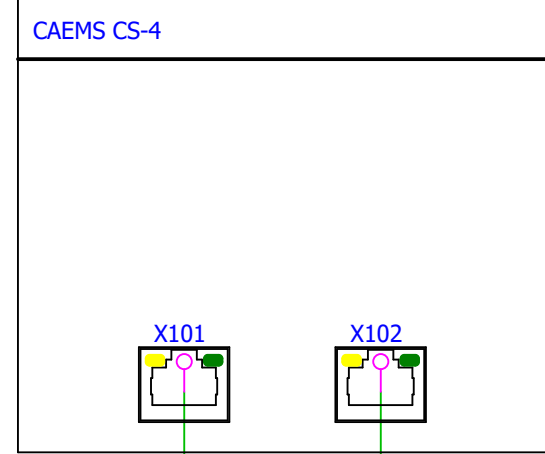

/11.3
/3.6
-OP-HMI1

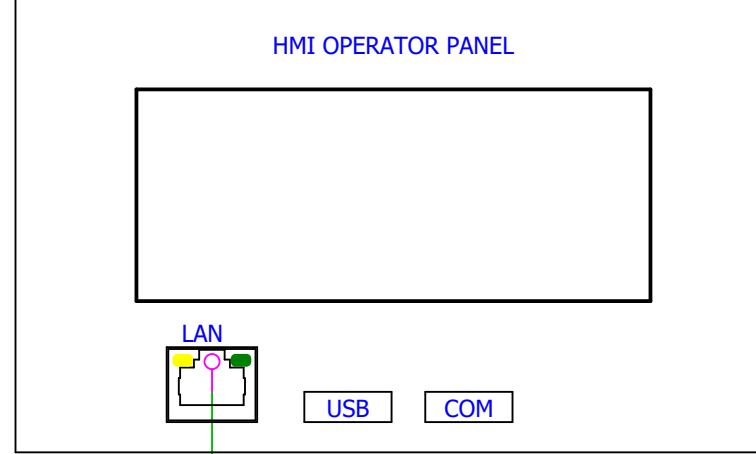

/3.5
-CS-3G-LAN

